

auto electrical parts

Technical Information Sheet

Part No. 0-531-80

24 Volt Illuminated Amber Round Rocker Switch

Durite's 24 Volt Illuminated Amber Round Rocker Switch.
24 volt 10 Amps DC. 50 ohm max. 4DPST on-off switch.

Actual Lens Colour: Amber



Technical Drawing (not to scale)

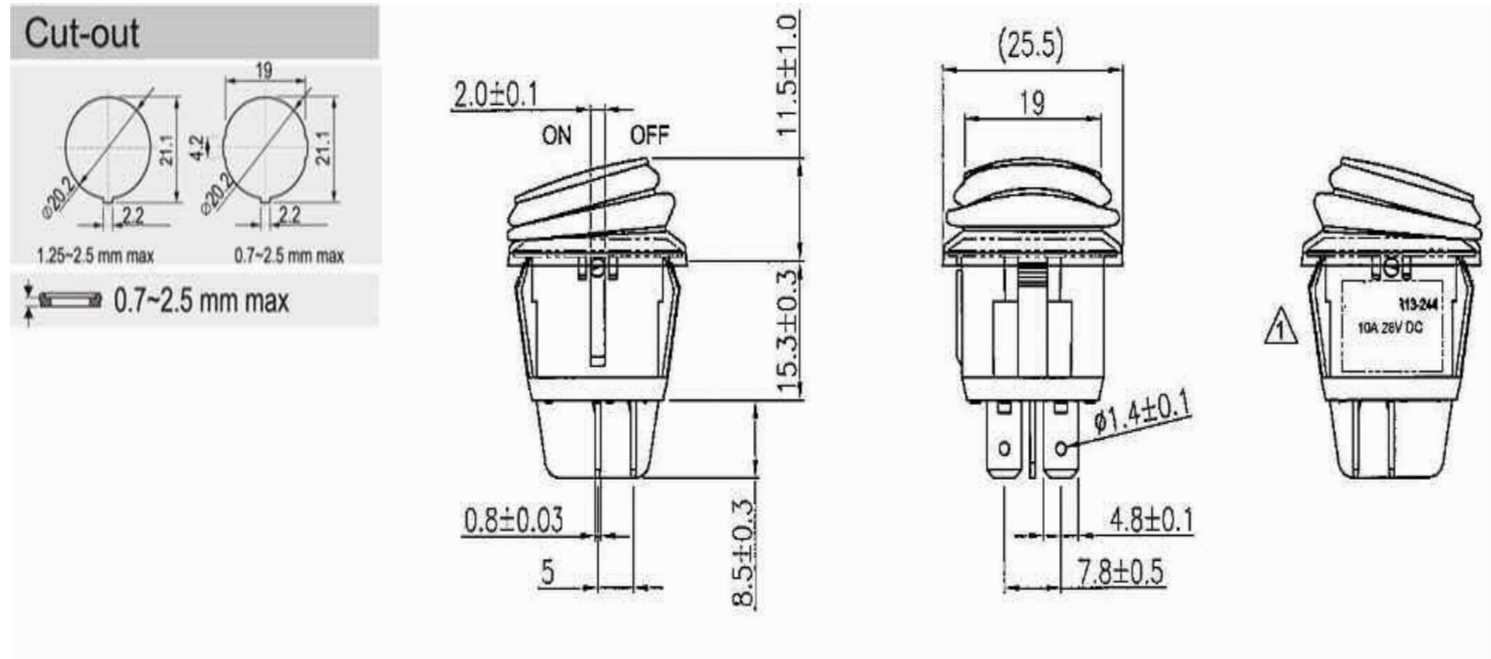

Specification

Voltage	24 Volt
Amps	10A
Contact Resistance	50 Ohm Max
Insulation Resistance	DC 500V 100M Ohm Min.
Diaelectric Strength	AC 1500V 1 Minute
Operation Temperature	-25 to 85C
Switch Function	4P DPST
IP Rating	IP65
Material:	Waterproof Rubber Silicone, Silver Plated Copper Alloy Terminals
Colour	Black body / Amber Lens
Certificate	n/a
Dimensions	Please see above (dimensions in mm)

The information contained in this document is correct to the best of our knowledge at the time of printing. However, specifications may change at any time without notice.